

Product Overview

Our TEG power module is specifically designed and manufactured to convert high temperature heat sources directly into electricity. The Bi-Te based thermoelectric modules can operate at temperatures as high as 330 °C (626 K) continuously and up to 400 °C (752 K) intermittently. The module will generate DC voltage if there is a temperature difference across the module. Power is generated as the temperature difference across the module increases. The efficiency of the module will also increase as well. Thermally conductivity graphite sheets have been applied to both sides of the ceramic plates to provide low contact thermal resistance. Therefore you do not need to apply thermal grease or other heat transfer compound when you install the module. The graphite sheet works very well in high temperatures.

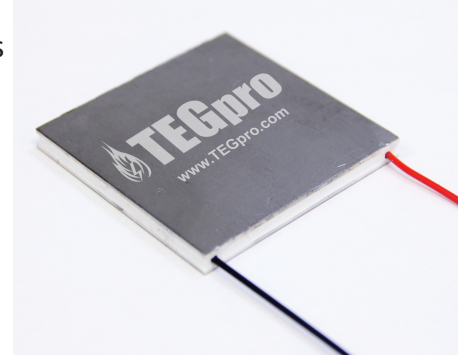

Specifications

Hot Side Temperature (°C)	300
Cold Side Temperature (°C)	30
Open Circuit Voltage (V)	14.4
Matched Load Resistance (ohms)	2.4
Matched load output voltage (V)	7.2
Matched load output current (A)	3.0
Matched load output power (W)	21.6
Heat flow across the module(W)	≈ 415
Heat flow density(W cm ⁻²)	≈ 13.2
AC Resistance (ohms) Measured under 27 °C at 1000 Hz	1.1 ~ 1.35

Specification of the Module

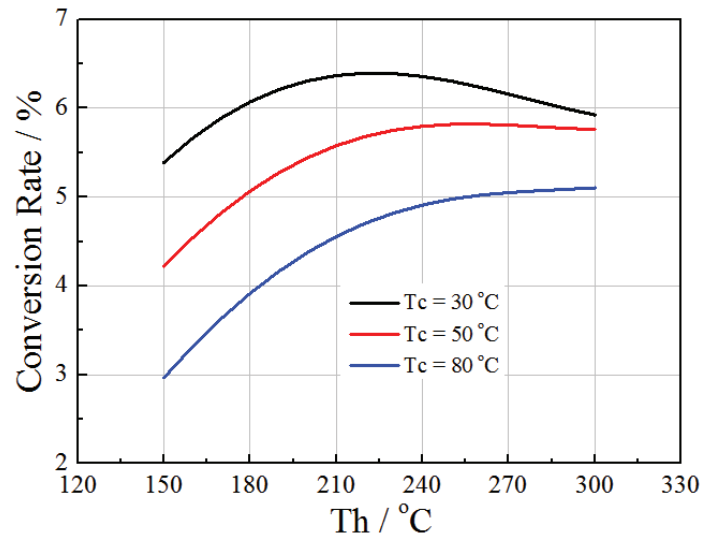

Note: Conversion rate = Matched load output power/Heat flow through the module

Performance

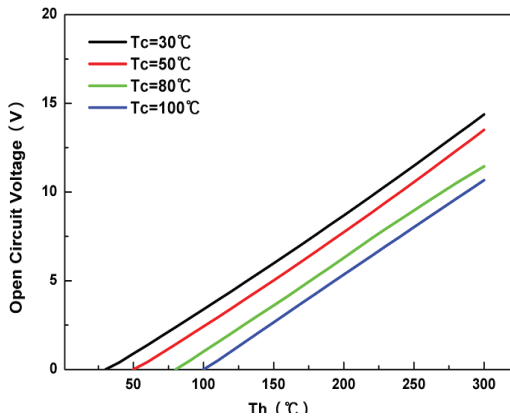

The chart for open circuit voltage Vs T_h under various T_c

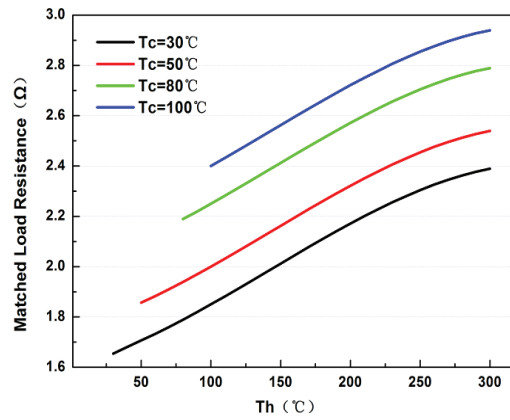

The chart for matched load resistance Vs T_h under various T_c

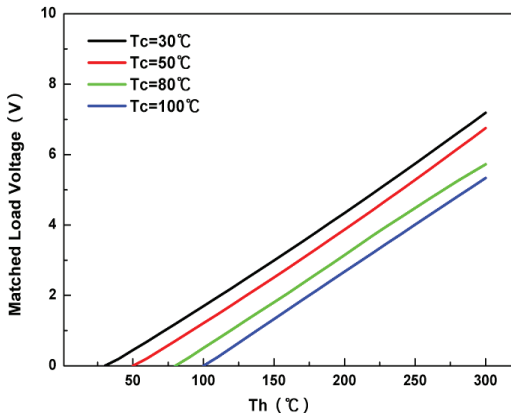

The chart for matched load voltage Vs T_h under various T_c

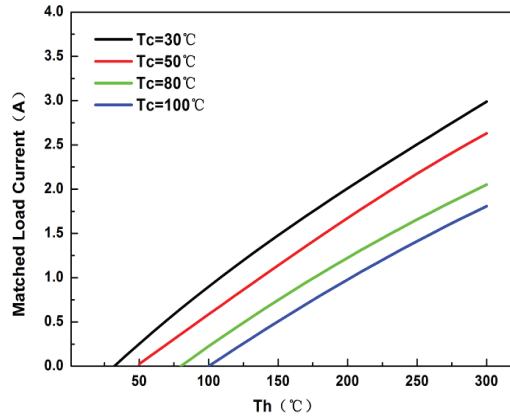

The chart for matched load current Vs T_h under various T_c

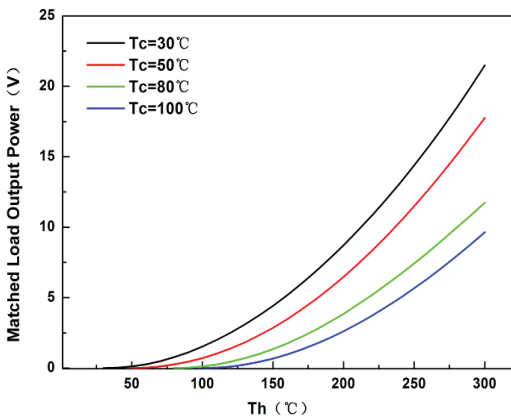

The chart for matched load output power Vs T_h under various T_c

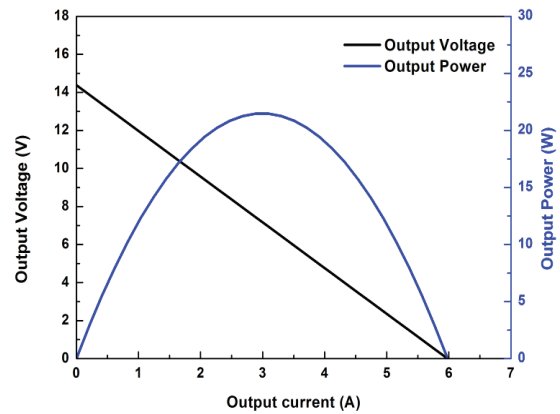

The chart for output voltage and output power Vs output current under $T_h=300^\circ\text{C}$ and $T_c=30^\circ\text{C}$

©2014 TEGpro www.tegpro.com.

Specifications subject to change without notice. Nov, 2014 - Rev 1.0

Dimensions

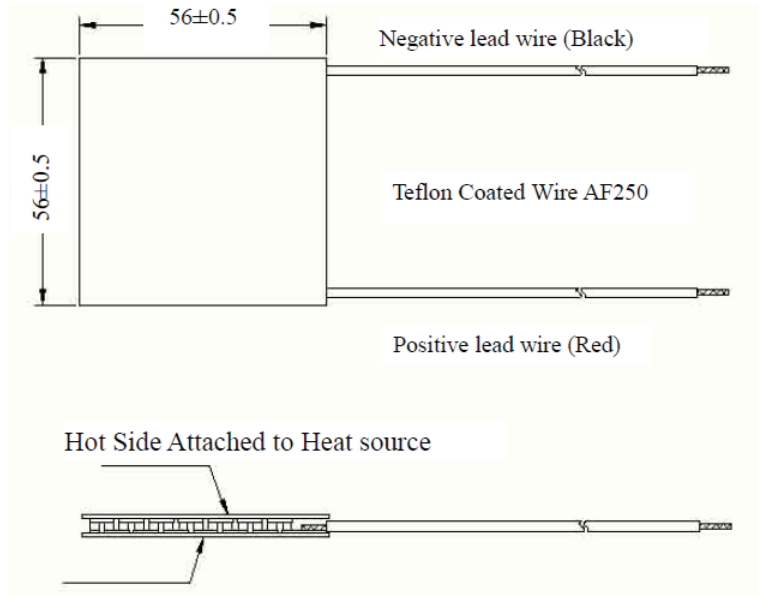

Cold Side Attached to Heat Sink for Heat Dissipation

