

**MODULE 3:**

**Hydrogen Use In  
Internal Combustion  
Engines**

**College of the Desert**  
Revision 0, December 2001

**XCELLSiS**  
*The Fuel Cell Engine Company*

**BALLARD**



## **CONTENTS**

3.1	HYDROGEN ENGINES .....	3-1
3.2	COMBUSTIVE PROPERTIES OF HYDROGEN .....	3-3
3.3	AIR/FUEL RATIO .....	3-6
3.4	PRE-IGNITION PROBLEMS AND SOLUTIONS .....	3-9
3.4.1	FUEL DELIVERY SYSTEMS .....	3-9
3.4.2	THERMAL DILUTION.....	3-12
3.4.3	ENGINE DESIGN.....	3-12
3.5	IGNITION SYSTEMS .....	3-14
3.6	CRANKCASE VENTILATION .....	3-15
3.7	THERMAL EFFICIENCY .....	3-16
3.8	EMISSIONS.....	3-17
3.9	POWER OUTPUT.....	3-19
3.10	HYDROGEN GAS MIXTURES.....	3-20
3.11	CURRENT STATUS .....	3-23



## **OBJECTIVES**

At the completion of this module, the technician will understand:

- the combustive properties of hydrogen that relate to its use as a combustive fuel
- the air/fuel ratio of hydrogen fuel mixtures and how it compares to other fuels
- the types of pre-ignition problems encountered in a hydrogen internal combustion engine and their solutions
- the type of ignition systems that may be used with hydrogen internal combustion engines
- crankcase ventilation issues that pertain to hydrogen use in an internal combustion engine
- the thermal efficiency of hydrogen internal combustion engines
- the type of emissions associated with hydrogen internal combustion engines
- the power output of hydrogen internal combustion engines
- the effect of mixing hydrogen with other hydrocarbon fuels



### 3.1 Hydrogen Engines

The small number of vehicles using hydrogen internal combustion engines (HICE) makes it difficult to explain how to repair them. Therefore, this section does not serve as a repair manual, but as an outline describing the operation of a hydrogen engine and its major components, its benefits, drawbacks and how components can be modified or re-designed to reduce the drawbacks.

In general, getting an internal combustion engine to run on hydrogen is not difficult. Getting an internal combustion engine to run well, however, is more of a challenge. This section points out the key components and techniques required to make the difference between a hydrogen engine that just runs and one that runs well.

The earliest attempt at developing a hydrogen engine was reported by Reverend W. Cecil in 1820. Cecil presented his work before the Cambridge Philosophical Society in a paper entitled "On the Application of Hydrogen Gas to Produce Moving Power in Machinery." The engine itself operated on the vacuum principle, in which atmospheric pressure drives a piston back against a vacuum to produce power. The vacuum is created by burning a hydrogen-air mixture, allowing it to expand and then cool. Although the engine ran satisfactorily, vacuum engines never became practical.



Figure 3-1 Hydrogen-Powered 1965 Cobra Replica

#### Key Points & Notes

Sixty years later, during his work with combustion engines in the 1860s and 1870s, N. A. Otto (the inventor of the Otto cycle) reportedly used a synthetic producer gas for fuel, which probably had a hydrogen content of over 50%. Otto also experimented with gasoline, but found it dangerous to work with, prompting him to return to using gaseous fuels. The development of the carburetor, however, initiated a new era in which gasoline could be used both practically and safely, and interest in other fuels subsided.

Hydrogen has since been used extensively in the space program since it has the best energy-to-weight ratio of any fuel. Liquid hydrogen is the fuel of choice for rocket engines, and has been utilized in the upper stages of launch vehicles on many space missions including the Apollo missions to the moon, Skylab, the Viking missions to Mars and the Voyager mission to Saturn.

In recent years, the concern for cleaner air, along with stricter air pollution regulation and the desire to reduce the dependency on fossil fuels have rekindled the interest in hydrogen as a vehicular fuel.



Figure 3-2 Hydrogen-Powered Pickup

### Key Points & Notes



### 3.2 Combustive Properties of Hydrogen

#### Key Points & Notes

The properties of hydrogen are detailed in Section 1. The properties that contribute to its use as a combustible fuel are its:

- wide range of flammability
- low ignition energy
- small quenching distance
- high autoignition temperature
- high flame speed at stoichiometric ratios
- high diffusivity
- very low density

#### *Wide Range of Flammability*

Hydrogen has a wide flammability range in comparison with all other fuels. As a result, hydrogen can be combusted in an internal combustion engine over a wide range of fuel-air mixtures. A significant advantage of this is that hydrogen can run on a lean mixture. A lean mixture is one in which the amount of fuel is less than the theoretical, stoichiometric or chemically ideal amount needed for combustion with a given amount of air. This is why it is fairly easy to get an engine to start on hydrogen.

Generally, fuel economy is greater and the combustion reaction is more complete when a vehicle is run on a lean mixture. Additionally, the final combustion temperature is generally lower, reducing the amount of pollutants, such as nitrogen oxides, emitted in the exhaust. There is a limit to how lean the engine can be run, as lean operation can significantly reduce the power output due to a reduction in the volumetric heating value of the air/fuel mixture.

#### *Low Ignition Energy*

Hydrogen has very low ignition energy. The amount of energy needed to ignite hydrogen is about one order of magnitude less than that required for gasoline. This enables hydrogen engines to ignite lean mixtures and ensures prompt ignition.

Unfortunately, the low ignition energy means that hot gases and hot spots on the cylinder can serve as sources of ignition, creating problems of premature ignition and flashback. Preventing this is one of the challenges associated with running an engine on hydrogen. The wide flammability range of

hydrogen means that almost any mixture can be ignited by a hot spot.

### *Small Quenching Distance*

Hydrogen has a small quenching distance, smaller than gasoline. Consequently, hydrogen flames travel closer to the cylinder wall than other fuels before they extinguish. Thus, it is more difficult to quench a hydrogen flame than a gasoline flame. The smaller quenching distance can also increase the tendency for backfire since the flame from a hydrogen-air mixture more readily passes a nearly closed intake valve, than a hydrocarbon-air flame.

### *High Autoignition Temperature*

Hydrogen has a relatively high autoignition temperature. This has important implications when a hydrogen-air mixture is compressed. In fact, the autoignition temperature is an important factor in determining what compression ratio an engine can use, since the temperature rise during compression is related to the compression ratio. The temperature rise is shown by the equation:

$$T_2 = T_1 \left( \frac{V_1}{V_2} \right)^{\gamma-1}$$

where:

$V_1/V_2$	= the compression ratio
$T_1$	= absolute initial temperature
$T_2$	= absolute final temperature
$\gamma$	= ratio of specific heats

The temperature may not exceed hydrogen's autoignition temperature without causing premature ignition. Thus, the absolute final temperature limits the compression ratio. The high autoignition temperature of hydrogen allows larger compression ratios to be used in a hydrogen engine than in a hydrocarbon engine.

This higher compression ratio is important because it is related to the thermal efficiency of the system as presented in Section 3.7. On the other hand, hydrogen is difficult to ignite in a compression ignition or diesel configuration, because the temperatures needed for those types of ignition are relatively high.

### *High Flame Speed*

Hydrogen has high flame speed at stoichiometric ratios. Under these conditions, the hydrogen flame speed is nearly an

### Key Points & Notes

order of magnitude higher (faster) than that of gasoline. This means that hydrogen engines can more closely approach the thermodynamically ideal engine cycle. At leaner mixtures, however, the flame velocity decreases significantly.

#### *High Diffusivity*

Hydrogen has very high diffusivity. This ability to disperse in air is considerably greater than gasoline and is advantageous for two main reasons. Firstly, it facilitates the formation of a uniform mixture of fuel and air. Secondly, if a hydrogen leak develops, the hydrogen disperses rapidly. Thus, unsafe conditions can either be avoided or minimized.

#### *Low Density*

Hydrogen has very low density. This results in two problems when used in an internal combustion engine. Firstly, a very large volume is necessary to store enough hydrogen to give a vehicle an adequate driving range. Secondly, the energy density of a hydrogen-air mixture, and hence the power output, is reduced.

#### Key Points & Notes

**3.3 Air/Fuel Ratio**

## Key Points &amp; Notes

The theoretical or stoichiometric combustion of hydrogen and oxygen is given as:

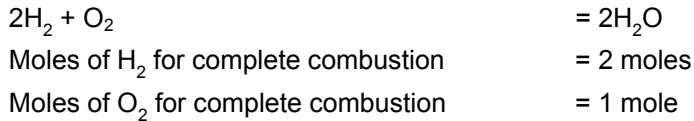

Because air is used as the oxidizer instead oxygen, the nitrogen in the air needs to be included in the calculation:

$$\begin{aligned} \text{Moles of N}_2 \text{ in air} &= \text{Moles of O}_2 \times (79\% \text{ N}_2 \text{ in air} / 21\% \text{ O}_2 \text{ in air}) \\ &= 1 \text{ mole of O}_2 \times (79\% \text{ N}_2 \text{ in air} / 21\% \text{ O}_2 \text{ in air}) \\ &= 3.762 \text{ moles N}_2 \\ \text{Number of moles of air} &= \text{Moles of O}_2 + \text{moles of N}_2 \\ &= 1 + 3.762 \\ &= 4.762 \text{ moles of air} \\ \text{Weight of O}_2 &= 1 \text{ mole of O}_2 \times 32 \text{ g/mole} \\ &= 32 \text{ g} \\ \text{Weight of N}_2 &= 3.762 \text{ moles of N}_2 \times 28 \text{ g/mole} \\ &= 105.33 \text{ g} \\ \text{Weight of air} &= \text{weight of O}_2 + \text{weight of N} \quad (1) \\ &= 32\text{g} + 105.33 \text{ g} \\ &= 137.33 \text{ g} \\ \text{Weight of H}_2 &= 2 \text{ moles of H}_2 \times 2 \text{ g/mole} \\ &= 4 \text{ g} \end{aligned}$$

Stoichiometric air/fuel (A/F) ratio for hydrogen and air is:

$$\begin{aligned} \text{A/F based on mass:} &= \text{mass of air/mass of fuel} \\ &= 137.33 \text{ g} / 4 \text{ g} \\ &= 34.33:1 \\ \text{A/F based on volume:} &= \text{volume (moles) of air/volume (moles) of fuel} \\ &= 4.762 / 2 \\ &= 2.4:1 \end{aligned}$$

The percent of the combustion chamber occupied by hydrogen for a stoichiometric mixture:

$$\begin{aligned} \% \text{ H}_2 &= \text{volume (moles) of H}_2 / \text{total volume} \quad (2) \\ &= \text{volume H}_2 / (\text{volume air} + \text{volume of H}_2) \\ &= 2 / (4.762 + 2) \end{aligned}$$

= 29.6%

As these calculations show, the stoichiometric or chemically correct A/F ratio for the complete combustion of hydrogen in air is about 34:1 by mass. This means that for complete combustion, 34 pounds of air are required for every pound of hydrogen. This is much higher than the 14.7:1 A/F ratio required for gasoline.

Since hydrogen is a gaseous fuel at ambient conditions it displaces more of the combustion chamber than a liquid fuel. Consequently less of the combustion chamber can be occupied by air. At stoichiometric conditions, hydrogen displaces about 30% of the combustion chamber, compared to about 1 to 2% for gasoline. Figure 3-3 compares combustion chamber volumes and energy content for gasoline and hydrogen fueled engines.

Key Points & Notes

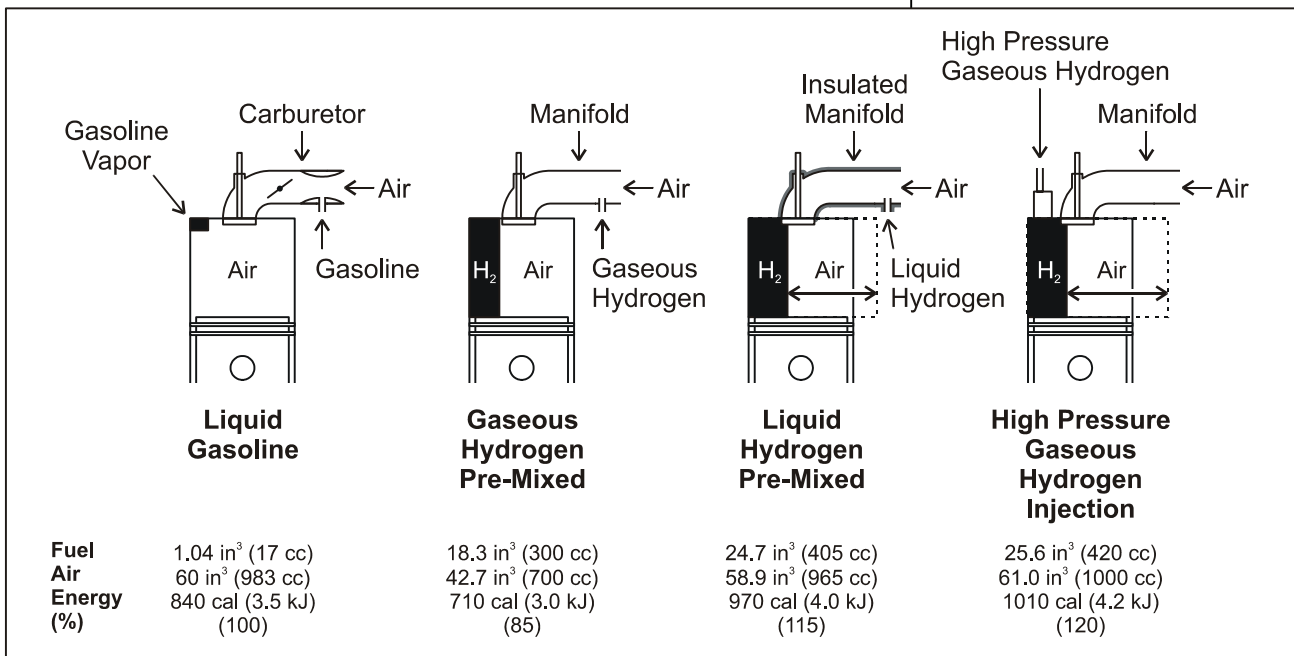

**Figure 3-3** Combustion Chamber Volumetric and Energy Comparison for Gasoline and Hydrogen Fueled Engines

Depending the method used to meter the hydrogen to the engine, the power output compared to a gasoline engine can be anywhere from 85% (intake manifold injection) to 120% (high pressure injection).

Because of hydrogen's wide range of flammability, hydrogen engines can run on A/F ratios of anywhere from 34:1 (stoichiometric) to 180:1. The A/F ratio can also be expressed in terms of equivalence ratio, denoted by phi ( $\Phi$ ). Phi is equal to the stoichiometric A/F ratio divided by the actual A/F ratio. For a stoichiometric mixture, the actual A/F ratio

is equal to the stoichiometric A/F ratio and thus the phi equals unity (one). For lean A/F ratios, phi will be a value less than one. For example, a phi of 0.5 means that there is only enough fuel available in the mixture to oxidize with half of the air available. Another way of saying this is that there is twice as much air available for combustion than is theoretically required.

**Key Points & Notes**

### 3.4 Pre-Ignition Problems and Solutions

#### Key Points & Notes

The primary problem that has been encountered in the development of operational hydrogen engines is premature ignition. Premature ignition is a much greater problem in hydrogen fueled engines than in other IC engines, because of hydrogen's lower ignition energy, wider flammability range and shorter quenching distance.

Premature ignition occurs when the fuel mixture in the combustion chamber becomes ignited before ignition by the spark plug, and results in an inefficient, rough running engine. Backfire conditions can also develop if the premature ignition occurs near the fuel intake valve and the resultant flame travels back into the induction system.

A number of studies have been aimed at determining the cause of pre-ignition in hydrogen engines. Some of the results suggest that pre-ignition are caused by hot spots in the combustion chamber, such as on a spark plug or exhaust valve, or on carbon deposits. Other research has shown that backfire can occur when there is overlap between the opening of the intake and exhaust valves.

It is also believed that the pyrolysis (chemical decomposition brought about by heat) of oil suspended in the combustion chamber or in the crevices just above the top piston ring can contribute to pre-ignition. This pyrolysed oil can enter the combustion chamber through blow-by from the crankcase (i.e. past the piston rings), through seepage past the valve guide seals and/or from the positive crankcase ventilation system (i.e. through the intake manifold).

#### 3.4.1 Fuel Delivery Systems

Adapting or re-designing the fuel delivery system can be effective in reducing or eliminating pre-ignition.

Hydrogen fuel delivery system can be broken down into three main types: central injection (or "carbureted"), port injection and direct injection.

Central and port fuel delivery systems injection form the fuel-air mixture during the intake stroke. In the case of central injection or a carburetor, the injection is at the inlet of the air intake manifold. In the case of port injection, it is injected at the inlet port.

Direct cylinder injection is more technologically sophisticated and involves forming the fuel-air mixture inside the combustion cylinder after the air intake valve has closed.

### *Central Injection or Carbureted Systems*

The simplest method of delivering fuel to a hydrogen engine is by way of a carburetor or central injection system. This system has advantages for a hydrogen engine. Firstly, central injection does not require the hydrogen supply pressure to be as high as for other methods. Secondly, central injection or carburetors are used on gasoline engines, making it easy to convert a standard gasoline engine to a hydrogen or a gasoline/hydrogen engine.

The disadvantage of central injection is that it is more susceptible to irregular combustion due to pre-ignition and backfire. The greater amount of hydrogen/air mixture within the intake manifold compounds the effects of pre-ignition.

### *Port Injection Systems*

The port injection fuel delivery system injects fuel directly into the intake manifold at each intake port, rather than drawing fuel in at a central point. Typically, the hydrogen is injected into the manifold after the beginning of the intake stroke. At this point conditions are much less severe and the probability for premature ignition is reduced.

In port injection, the air is injected separately at the beginning of the intake stroke to dilute the hot residual gases and cool any hot spots. Since less gas (hydrogen or air) is in the manifold at any one time, any pre-ignition is less severe. The inlet supply pressure for port injection tends to be higher than for carbureted or central injection systems, but less than for direct injection systems.

The constant volume injection (CVI) system uses a mechanical cam-operated device to time the injection of the hydrogen to each cylinder. The CVI block is shown on the far right of the photo with four fuel lines exiting on left side of the block (one fuel line for each cylinder).

The electronic fuel injection (EFI) system meters the hydrogen to each cylinder. This system uses individual electronic fuel injectors (solenoid valves) for each cylinder and are plumbed to a common fuel rail located down the center of the intake manifold. Whereas the CVI system uses constant injection timing and variable fuel rail pressure, the EFI system uses variable injection timing and constant fuel rail pressure.

### Key Points & Notes

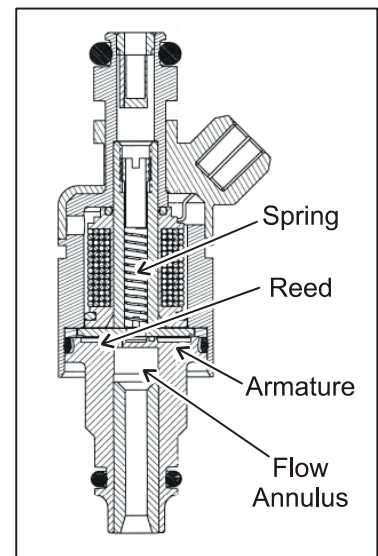

*Electronic Fuel Injector*



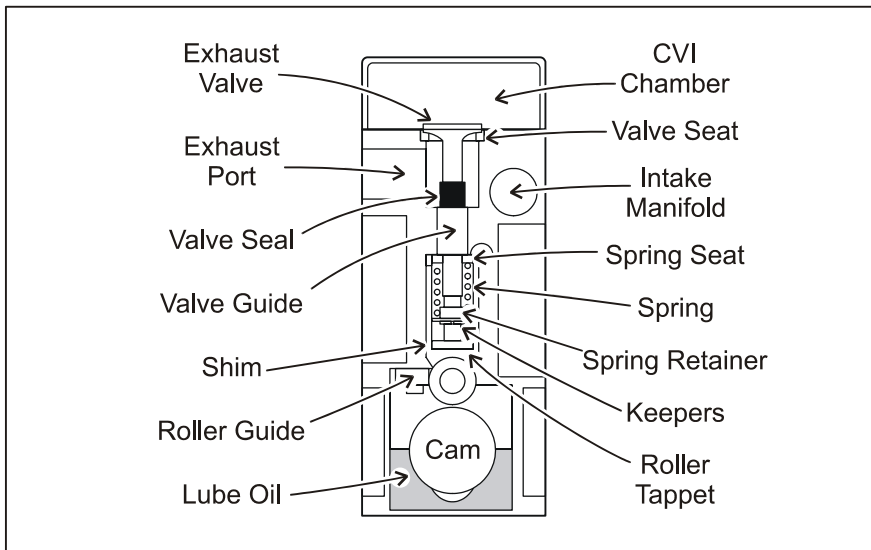

**Figure 3-4** Constant Volume Injector

Examples of port injection type systems are shown in Figure 3-5.

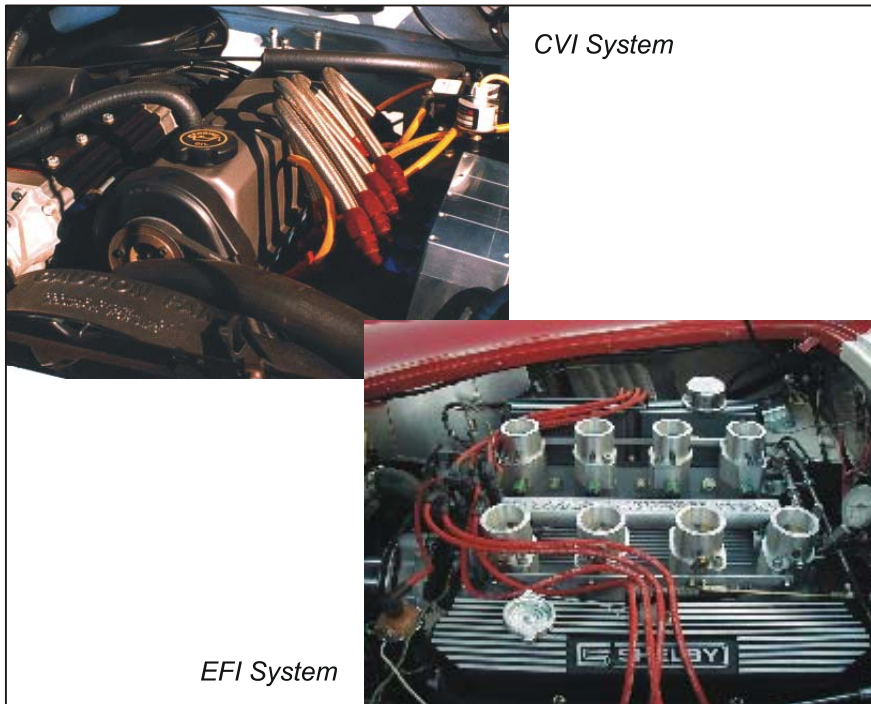

**Figure 3-5** CVI and EFI Port Injection Systems

### *Direct Injection Systems*

More sophisticated hydrogen engines use direct injection into the combustion cylinder during the compression stroke. In direct injection, the intake valve is closed when the fuel is injected, completely avoiding premature ignition during the

### Key Points & Notes

intake stroke. Consequently the engine cannot backfire into the intake manifold.

The power output of a direct injected hydrogen engine is 20% more than for a gasoline engine and 42% more than a hydrogen engine using a carburetor.

While direct injection solves the problem of pre-ignition in the intake manifold, it does not necessarily prevent pre-ignition within the combustion chamber. In addition, due to the reduced mixing time of the air and fuel in a direct injection engine, the air/fuel mixture can be non-homogenous. Studies have suggested this can lead to higher NO<sub>x</sub> emissions than the non-direct injection systems. Direct injection systems require a higher fuel rail pressure than the other methods.

### 3.4.2 Thermal Dilution

Pre-ignition conditions can be curbed using thermal dilution techniques such as exhaust gas recirculation (EGR) or water injection.

As the name implies, an EGR system recirculates a portion of the exhaust gases back into the intake manifold. The introduction of exhaust gases helps to reduce the temperature of hot spots, reducing the possibility of pre-ignition. Additionally, recirculating exhaust gases reduce the peak combustion temperature, which reduces NO<sub>x</sub> emissions. Typically a 25 to 30% recirculation of exhaust gas is effective in eliminating backfire.

On the other hand, the power output of the engine is reduced when using EGR. The presence of exhaust gases reduces the amount of fuel mixture that can be drawn into the combustion chamber.

Another technique for thermally diluting the fuel mixture is the injection of water. Injecting water into the hydrogen stream prior to mixing with air has produced better results than injecting it into the hydrogen-air mixture within the intake manifold. A potential problem with this type of system is that water can get mixed with the oil, so care must be taken to ensure that seals do not leak.

### 3.4.3 Engine Design

The most effective means of controlling pre-ignition and knock is to re-design the engine for hydrogen use, specifically the combustion chamber and the cooling system.

## Key Points & Notes

A disk-shaped combustion chamber (with a flat piston and chamber ceiling) can be used to reduce turbulence within the chamber. The disk shape helps produce low radial and tangential velocity components and does not amplify inlet swirl during compression.

Since unburned hydrocarbons are not a concern in hydrogen engines, a large bore-to-stroke ratio can be used with this engine. To accommodate the wider range of flame speeds that occur over a greater range of equivalence ratios, two spark plugs are needed. The cooling system must be designed to provide uniform flow to all locations that need cooling.

Additional measures to decrease the probability of pre-ignition are the use of two small exhaust valves as opposed to a single large one, and the development of an effective scavenging system, that is, a means of displacing exhaust gas from the combustion chamber with fresh air.

### Key Points & Notes



**Figure 3-6** Hydrogen Internal Combustion Engine

### 3.5 Ignition Systems

Due to hydrogen's low ignition energy limit, igniting hydrogen is easy and gasoline ignition systems can be used. At very lean air/fuel ratios (130:1 to 180:1) the flame velocity is reduced considerably and the use of a dual spark plug system is preferred.

Ignition systems that use a waste spark system should not be used for hydrogen engines. These systems energize the spark each time the piston is at top dead center whether or not the piston is on the compression stroke or on its exhaust stroke. For gasoline engines, waste spark systems work well and are less expensive than other systems. For hydrogen engines, the waste sparks are a source of pre-ignition.

Spark plugs for a hydrogen engine should have a cold rating and have non-platinum tips. A cold-rated plug is one that transfers heat from the plug tip to the cylinder head quicker than a hot-rated spark plug. This means the chances of the spark plug tip igniting the air/fuel charge is reduced. Hot-rated spark plugs are designed to maintain a certain amount of heat so that carbon deposits do not accumulate. Since hydrogen does not contain carbon, hot-rated spark plugs do not serve a useful function.

Platinum-tip spark plugs should also be avoided since platinum is a catalyst, causing hydrogen to oxidize with air.

#### Key Points & Notes

### 3.6 Crankcase Ventilation

Crankcase ventilation is even more important for hydrogen engines than for gasoline engines.

As with gasoline engines, unburnt fuel can seep by the piston rings and enter the crankcase. Since hydrogen has a lower energy ignition limit than gasoline, any unburnt hydrogen entering the crankcase has a greater chance of igniting. Hydrogen should be prevented from accumulating through ventilation.

Ignition within the crankcase can be just a startling noise or result in engine fire. When hydrogen ignites within the crankcase, a sudden pressure rise occurs. To relieve this pressure, a pressure relief valve must be installed on the valve cover. A typical pressure relief valve installation is shown in Figure 3-7.



**Figure 3-7** Pressure Relief Valve on Engine Crankcase

Exhaust gases can also seep by the piston rings into the crankcase. Since hydrogen exhaust is water vapor, water can condense in the crankcase when proper ventilation is not provided. The mixing of water into the crankcase oil reduces its lubrication ability, resulting in a higher degree of engine wear.

#### Key Points & Notes

### 3.7 Thermal Efficiency

The theoretical thermodynamic efficiency of an Otto cycle engine is based on the compression ratio of the engine and the specific-heat ratio of the fuel as shown in the equation:

$$\eta_{th} = 1 - \frac{1}{\left(\frac{V_1}{V_2}\right)^\gamma}$$

where:

- $V_1/V_2$  = the compression ratio
- $\gamma$  = ratio of specific heats
- $\eta_{th}$  = theoretical thermodynamic efficiency

The higher the compression ratio and/or the specific-heat ratio, the higher the indicated thermodynamic efficiency of the engine. The compression ratio limit of an engine is based on the fuel's resistance to knock. A lean hydrogen mixture is less susceptible to knock than conventional gasoline and therefore can tolerate higher compression ratios.

The specific-heat ratio is related to the fuel's molecular structure. The less complex the molecular structure, the higher the specific-heat ratio. Hydrogen ( $\gamma = 1.4$ ) has a much simpler molecular structure than gasoline and therefore its specific-heat ratio is higher than that of conventional gasoline ( $\gamma = 1.1$ ).

#### Key Points & Notes

### 3.8 Emissions

The combustion of hydrogen with oxygen produces water as its only product:

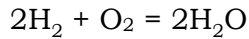

The combustion of hydrogen with air however can also produce oxides of nitrogen (NO<sub>x</sub>):

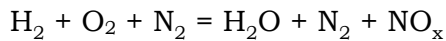

The oxides of nitrogen are created due to the high temperatures generated within the combustion chamber during combustion. This high temperature causes some of the nitrogen in the air to combine with the oxygen in the air. The amount of NO<sub>x</sub> formed depends on:

- the air/fuel ratio
- the engine compression ratio
- the engine speed
- the ignition timing
- whether thermal dilution is utilized

In addition to oxides of nitrogen, traces of carbon monoxide and carbon dioxide can be present in the exhaust gas, due to seeped oil burning in the combustion chamber.

Depending on the condition of the engine (burning of oil) and the operating strategy used (a rich versus lean air/fuel ratio), a hydrogen engine can produce from almost zero emissions (as low as a few ppm) to high NO<sub>x</sub> and significant carbon monoxide emissions.

Figure 3-8 illustrates a typically NO<sub>x</sub> curve relative to phi for a hydrogen engine. A similar graph including other emissions is shown in Figure 3-9 for gasoline.

### Key Points & Notes

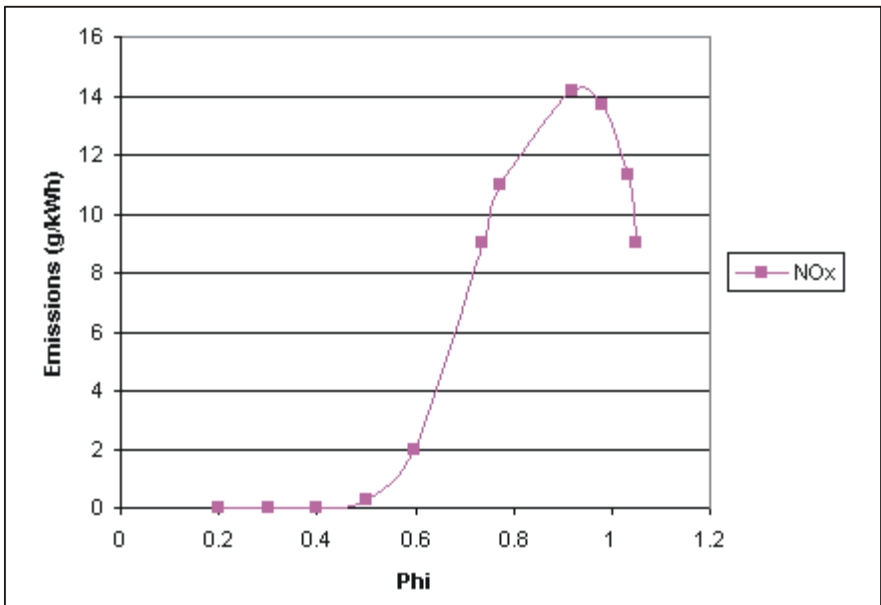

Figure 3-8 Emissions For A Hydrogen Engine

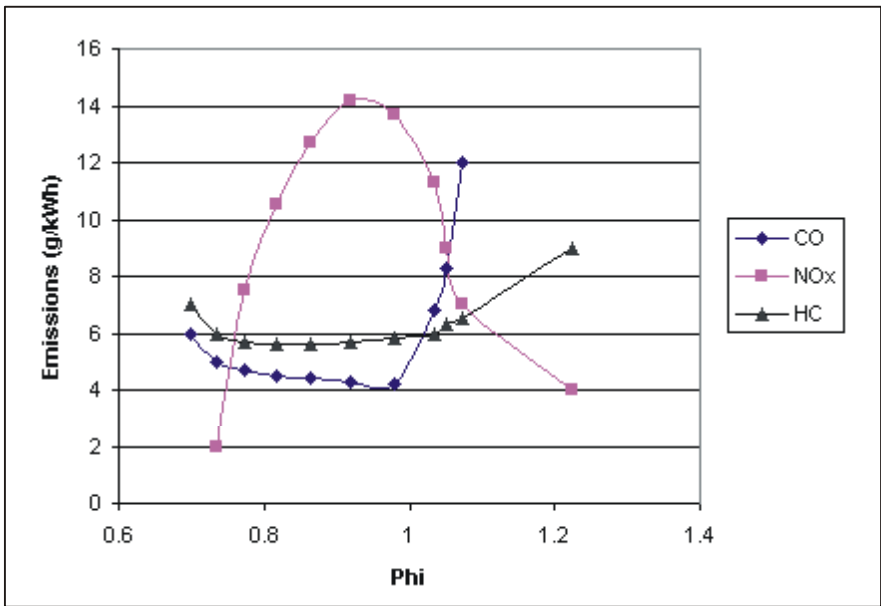

Figure 3-9 Emissions For A Gasoline Engine

As Figure 3-9 shows, the NOx for a gasoline engine is reduced as phi decreases (similar to a hydrogen engine). However, in a gasoline engine the reduction in NOx is compromised by an increase in carbon monoxide and hydrocarbons.

Key Points & Notes



### 3.9 Power Output

The theoretical maximum power output from a hydrogen engine depends on the air/fuel ratio and fuel injection method used.

As mentioned in Section 3.3, the stoichiometric air/fuel ratio for hydrogen is 34:1. At this air/fuel ratio, hydrogen will displace 29% of the combustion chamber leaving only 71% for the air. As a result, the energy content of this mixture will be less than it would be if the fuel were gasoline (since gasoline is a liquid, it only occupies a very small volume of the combustion chamber, and thus allows more air to enter).

Since both the carbureted and port injection methods mix the fuel and air prior to it entering the combustion chamber, these systems limit the maximum theoretical power obtainable to approximately 85% of that of gasoline engines. For direct injection systems, which mix the fuel with the air after the intake valve has closed (and thus the combustion chamber has 100% air), the maximum output of the engine can be approximately 15% higher than that for gasoline engines.

Therefore, depending on how the fuel is metered, the maximum output for a hydrogen engine can be either 15% higher or 15% less than that of gasoline if a stoichiometric air/fuel ratio is used. However, at a stoichiometric air/fuel ratio, the combustion temperature is very high and as a result it will form a large amount of nitrogen oxides (NO<sub>x</sub>), which is a criteria pollutant. Since one of the reasons for using hydrogen is low exhaust emissions, hydrogen engines are not normally designed to run at a stoichiometric air/fuel ratio.

Typically hydrogen engines are designed to use about twice as much air as theoretically required for complete combustion. At this air/fuel ratio, the formation of NO<sub>x</sub> is reduced to near zero. Unfortunately, this also reduces the power output to about half that of a similarly sized gasoline engine. To make up for the power loss, hydrogen engines are usually larger than gasoline engines, and/or are equipped with turbochargers or superchargers.

#### Key Points & Notes

### 3.10 Hydrogen Gas Mixtures

Hydrogen can be used advantageously in internal combustion engines as an additive to a hydrocarbon fuel.

Hydrogen is most commonly mixed with high pressure natural gas for this purpose since both gases can be stored in the same tank. If hydrogen is blended with other fuels, it usually has to be stored separately and mixed in the gaseous state immediately before ignition. In general, it is impractical to use hydrogen in conjunction with other fuels that also require bulky storage systems, such as propane.

Gaseous hydrogen cannot be stored in the same vessel as a liquid fuel. Hydrogen's low density will cause it to remain on top of the liquid and not mix. Furthermore, liquid fuels are stored at relatively low pressures so that very little hydrogen could be added to the vessel.

Liquid hydrogen cannot be stored in the same vessel as other fuels. Hydrogen's low boiling point will freeze other fuels resulting in fuel "ice"!

Hydrogen can be used in conjunction with compact liquid fuels such as gasoline, alcohol or diesel provided each are stored separately. In these applications, the fuel tanks can be formed to fit into unused spaces on the vehicle. Existing vehicles of this type tend to operate using one fuel or the other but not both at the same time. One advantage of this strategy is that the vehicle can continue to operate if hydrogen is unavailable.

Hydrogen cannot be used directly in a diesel (or "compression ignition") engine since hydrogen's autoignition temperature is too high (this is also true of natural gas). Thus, diesel engines must be outfitted with spark plugs or use a small amount of diesel fuel to ignite the gas (known as pilot ignition). Although pilot ignition techniques have been developed for use with natural gas, no one is currently doing this with hydrogen.

One commercially available gas mixture known as Hythane contains 20% hydrogen and 80% natural gas. At this ratio, no modifications are required to a natural gas engine, and studies have shown that emissions are reduced by more than 20%. Mixtures of more than 20% hydrogen with natural gas can reduce emissions further but some engine modifications are required.

#### Key Points & Notes



*NRG Tech Natural Gas /  
Hydrogen Ford Pickup*



*Ford Alcohol-Fueled Pickup*

Lean operation of any internal combustion engine is advantageous in terms of oxides of nitrogen emissions and fuel economy.



**Figure 3-10** Hythane Powered Bus

For hydrocarbon engines, lean operation also leads to lower emissions of carbon monoxide and unburned hydrocarbons. As more oxygen is available than required to combust the fuel, the excess oxygen oxidizes more carbon monoxide into carbon dioxide, a less harmful emission. The excess oxygen also helps to complete the combustion, decreasing the amount of unburned hydrocarbons.

As with hydrogen, the drawback of lean operation with hydrocarbon fuels is a reduced power output. Lean operation of hydrocarbon engines has additional drawbacks. Lean mixtures are hard to ignite, despite the mixture being above the LFL of the fuel. This results in misfire, which increases unburned hydrocarbon emissions, reduces performance and wastes fuel. Another disadvantage is the reduced conversion efficiency of 3-way catalytic converters, resulting in more harmful emissions.

To some extent, mixing hydrogen with other hydrocarbon fuels reduces all of these drawbacks. Hydrogen's low ignition energy limit and high burning speed makes the hydrogen/hydrocarbon mixture easier to ignite, reducing misfire and thereby improving emissions, performance and fuel economy. Regarding power output, hydrogen augments the mixture's energy density at lean mixtures by increasing the hydrogen-to-carbon ratio, and thereby improves torque at wide-open throttle conditions.

### Key Points & Notes

However, the difficulty associated with storing adequate amounts of hydrogen can reduce vehicle range.

Key Points & Notes

### 3.11 Current Status

A few auto manufacturers have been doing some work in the development of hydrogen-powered vehicles (Ford has recently announced that they have developed a “production ready” hydrogen-powered vehicle using an ICE and BMW has completed a world tour displaying a dozen or so hydrogen-powered 750i vehicles). However, it is not likely that any hydrogen-powered vehicles will be available to the public until there is an adequate refueling infrastructure and trained technicians to repair and maintain these vehicles.



Courtesy of Jo Borck

**Figure 3-11** BMW's Hydrogen-Powered Internal Combustion Vehicle

Like current gasoline-powered vehicles, the design of each hydrogen-powered vehicle will most likely vary from manufacturer to manufacturer and model to model. One model may be simple in design and operation, for example, a lean-burning fuel metering strategy using no emission control systems such as EGR, catalytic converter, evaporate fuel canister, etc. Another model may be very sophisticated in design and operation, for example, using an EGR fuel metering strategy with a catalytic converter, multiple spark plugs, etc.

Until such time that a hydrogen infrastructure exists, hydrogen/natural gas fuel blends provide a logical transition to fully hydrogen-powered vehicles. These vehicles can operate on either fuel, depending on availability.

### Key Points & Notes